

BUILT-IN & UNIVERSAL FIT WALL AIR CONDITIONERS



PRODUCT AND ACCESSORIES GUIDE



BUILT-IN WALL AIR CONDITIONERS

GE Appliances built-in wall air conditioners offer reliable, efficient, and convenient cooling and heating. True built-in design gives a seamless appearance and a precise fit. Installation flexibility is provided with two unique mounting configurations—standard and our EXCLUSIVE high mount.

With WIFI on-board powered by SmartHQ™, you can monitor and control your air conditioner on your smart phone or tablet by using the SmartHQ app. Available through the Apple app store and Google play, WIFI capability through internet connectivity enables SmartHQ home automations such as setting a cooling/heating schedule and enabling voice control.

The following features are available on SmartHQ units:

- Voice Control capable with Amazon Alexa & Google Home
- 7-day scheduling to cool or heat your home from anywhere
- Control multiple air conditioners at once in one convenient app
- Monitor energy usage to keep your monthly utility bills at a minimum

Whether a new build or renovation, choose our new WIFI on-board powered by SmartHQ air conditioners—backed by the brand you know and trust.

In addition to full-featured control via the app, convenient temperature control is made possible via remote control and a built-in timer to power the unit on/off at your choosing.

good things, for life.  **GE APPLIANCES**



*SmartHQ™
technology
enables you
to control
and monitor
settings
while away
from home.*



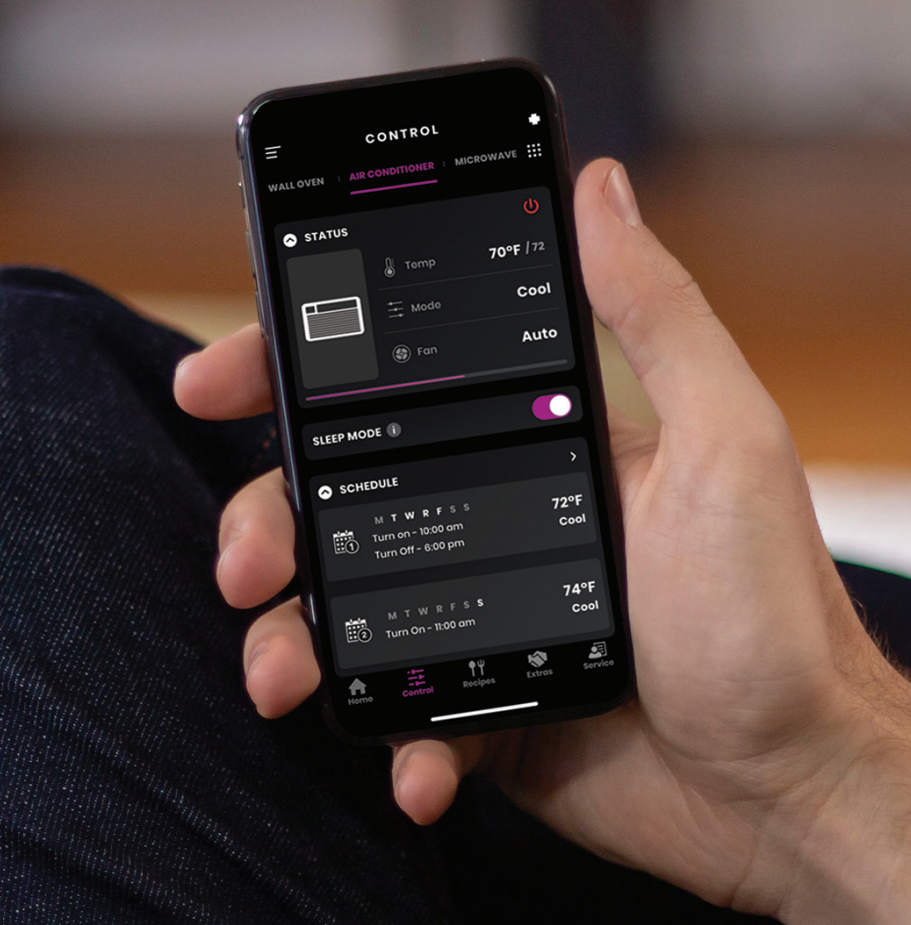

BUILT-IN FEATURE HIGHLIGHTS



TRUE BUILT-IN DESIGN

The ultimate fit & finish for more usable space and the best in built-in installation. Sleeve and chassis are perfectly matched, creating a seamless fit without leaks or gaps.



PREMIUM GUARD SEACOAST PROTECTION*

Premium Seacoast Protection on heat/cool models use stainless steel screws, special coatings and double coats of paint on key components including coils, base pan, compressor.



ELECTRONIC CAP TOUCH CONTROLS

Controls offer a high-end and smooth to-the-touch panel.

Keep your place cool, no matter where you are.

GE Smart Air Conditioners enabled with SmartHQ™ technology allow you to monitor and control your air conditioner from anywhere.

With the SmartHQ app, you'll be able to:

- Create your own cooling schedule
- Monitor and control your air conditioner
- Control multiple air conditioners with one app
- Get reminders to clean or change your air conditioner's filter



*Heat/cool models only.



HEAT MODE*

On days when cool air is not needed, the Heat Mode provides a warm and comfortable room temperature.



3 FAN SPEEDS

Select high, medium, low or auto setting to achieve the best in air comfort & ultimate flexibility.



ECO MODE

Innovative mode where the fan cycles off between cooling intervals, saving energy while keeping the room comfortable.



DRY MODE

Designed for humid environments, it helps provide a dryer & more comfortable environment with room-air dehumidification.



LARGE LCD AUTO-DIMMING DISPLAY

Large, intuitive white LCD display can be easily seen from anywhere in the room. Convenient Auto-Dimming feature via remote promotes ambient lighting during the night.

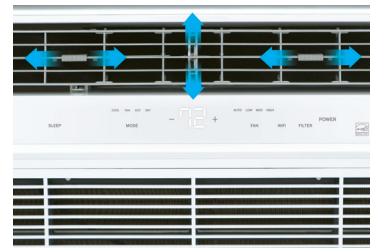

6-WAY DIRECTIONAL AIRFLOW

Direct where the air flows with up to 6 directional vent adjustments—cooling and/or heating the areas of the room that need it the most.



SLIM ROOM FRONT

A slim room front provides more usable space in the room. It's the sleekest design in the industry.



REMOTE CONTROL INCLUDED

Slim, intuitive remote control enables adjusting temperatures and settings conveniently from anywhere in the room.

*Heat/cool models only.

BUILT-IN COOL-ONLY WALL AIR CONDITIONERS

COOL-ONLY UNITS INCLUDE:

- Built-In WiFi powered by SmartHQ™
- ENERGY STAR® certified
- 3 fan speeds
- Electronic controls with remote
- Electronic digital thermostat
- Six-way air direction
- Upfront, washable air filter
- Standard-mount and high-mount configurations



ADA
COMPLIANT



IFTTT



ADA
COMPLIANT



STANDARD-MOUNT

AJQC10DWH

10,150/9,900 BTU, 10.6/10.6 CEER, 230/208 Volts

AJQC12DWH

12,000/11,700 BTU, 10.5/10.5 CEER, 230/208 Volts

AJQC14DWH*

14,000/13,500 BTU, 9.3/9.5 CEER, 230/208 Volts

*Not ENERGY STAR certified.

AJQC06LWH

6,300 BTU, 11.0 CEER, 115 Volts

AJQC08AWH

8,400 BTU, 10.6 CEER, 115 Volts

AJQC10AWH

10,000 BTU, 10.6 CEER, 115 Volts

AJQC12AWH

12,000 BTU, 10.5 CEER, 115 Volts

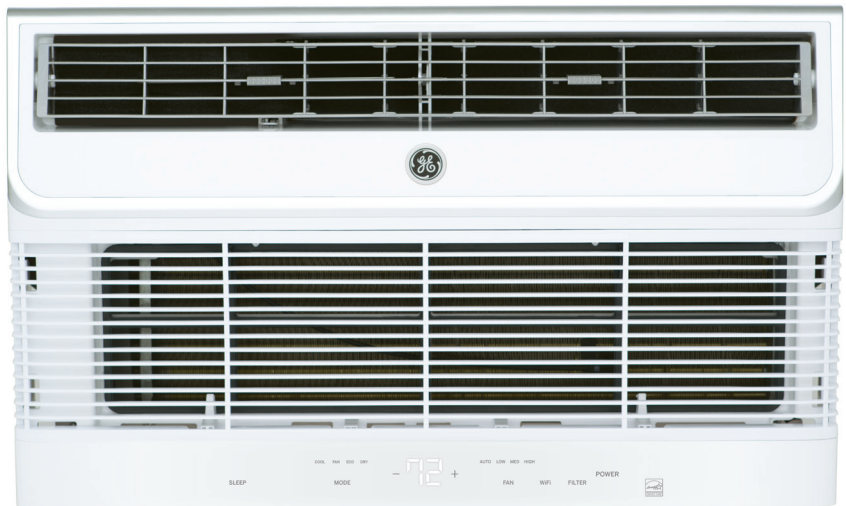

HIGH-MOUNT

AJCM10DWH

10,150/9,900 BTU, 10.6/10.6 CEER, 230/208 Volts

AJCM12DWH

12,000/11,700 BTU, 10.5/10.5 CEER, 230/208 Volts

AJCM08AWH

8,400 BTU, 10.6 CEER, 115 Volts

AJCM10AWH

10,000 BTU, 10.6 CEER, 115 Volts

Specifications subject to change.

BUILT-IN HEAT/COOL WALL AIR CONDITIONERS

HEAT/COOL UNITS INCLUDE:

- Built-In WiFi powered by SmartHQ™
- 3 fan speeds
- Electronic controls with remote
- Electronic digital thermostat
- Six-way air direction
- Remote thermostat capable
- Upfront, washable air filter
- Standard-mount and high-mount configurations
- Heat pump models include backup resistance heat options



ADA COMPLIANT



STANDARD-MOUNT*

AJEQ08AWH

8,300 BTU Cool, 4,200 BTU Heat, 9.6 CEER, 115 Volts (Not a primary heat source)

AJEQ10DWH

10,000/9,800 BTU Cool, 10,600/8,600 BTU Heat, 9.6/9.6 CEER, 230/208 Volts

AJEQ12DWH

12,000/11,700 BTU Cool, 10,600/8,600 BTU Heat, 9.5/9.5 CEER, 230/208 Volts

AJEQ14DWH

14,000/13,600 BTU Cool, 106,00/8,600 BTU Heat, 9.3/9.5 CEER, 230/208 Volts

HEAT PUMP

AJHQ08AWH

8,200 BTU Cool, 6,650 BTU Rev Cyc Heat, 4,200 BTU Elec Heat, 9.8 CEER, 115 Volts

AJHQ12DWH

11,500/11,100 BTU Cool, 8,500/8,300 BTU Rev Cyc Heat, 10,600/8,600 BTU Elec Heat, 9.6/9.6 CEER, 230/208 Volts



IFTTT



ADA COMPLIANT

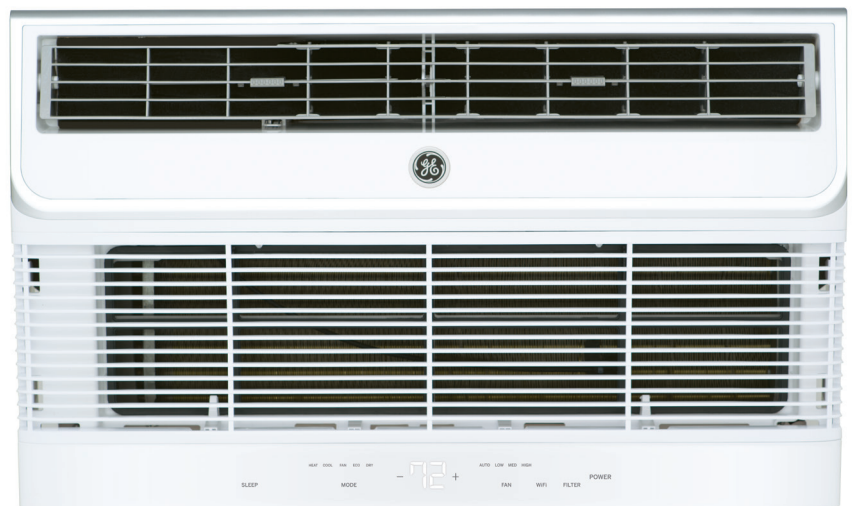

HIGH-MOUNT*

AJEM12DWH

12,000/11,700 BTU Cool, 10,600/8,600 BTU Heat, 9.5 /9.5 CEER, 230/208 Volts

*Non-ENERGY STAR models
Specifications subject to change.

SPECIFICATIONS

COOL-ONLY

MODELS	AJCQ06LWH	AJCQ08AWH	AJCQ10AWH	AJCQ12AWH	AJCQ10DWH
ENERGY STAR® Certified	Yes	Yes	Yes	Yes	Yes
Built-in WiFi SmartHQ™	Yes	Yes	Yes	Yes	Yes
ADA-Compliant	Yes	Yes	Yes	Yes	Yes
Voltage / Hertz / Phase	115 / 60 / 1	115 / 60 / 1	115 / 60 / 1	115 / 60 / 1	230 / 208 / 60 / 1
BTU - AHAM Cooling	6,300	8,400	10,000	12,000	10,150 / 9,900
Amps - AHAM	5.0	7.0	8.3	10.2	4.5 / 4.8
Watts	560	790	930	1130	950 / 920
EER	11.0	10.6	10.6	10.5	10.6 / 10.6
CEER	11.0	10.6	10.6	10.5	10.6 / 10.6
Dehumid. (Pts/Hr)	1.3	1.9	2.7	3.4	2.7 / 2.7
Refrigerant Type	R410A	R410A	R410A	R410A	R410A
Circuit Size (Amps.)	15	15	15	15	15
Line Cord Plug / Configuration	Parallel / NEMA 5-15P Right Angle LCDI	Parallel / NEMA 5-15P Right Angle LCDI	Parallel / NEMA5-15P Right Angle LCDI	Parallel / NEMA 5-15P Right Angle LCDI	Tandem / NEMA 6-15P Right Angle LCDI
Electronic Control	Yes	Yes	Yes	Yes	Yes
Filter Reminder Function	Yes	Yes	Yes	Yes	Yes
Filter Type	Rigid, tilt out / washable	Rigid, tilt out / washable	Rigid, tilt out / washable	Rigid, tilt out / washable	Rigid, tilt out / washable
Remote	Yes	Yes	Yes	Yes	Yes
Fan Speeds	3	3	3	3	3
Chassis Width, Inches	26-2/32	26-2/32	26-2/32	26-2/32	26-2/32
Chassis Height, Inches	15-21/32	15-21/32	15-21/32	15-21/32	15-21/32
Chassis Depth Inches	21-2/32	21-2/32	21-2/32	21-2/32	21-2/32
Approx. Net Weight (lbs.)	62	64	67	73	67
Approx. Shipping Weight (lbs.)	72	73	77	83	77

Specifications subject to change.

HEAT/COOL

HIGH-MOUNT

MODELS	AJEQ08AWH	AJEQ10DWH	AJEQ12DWH	AJEQ14DWH	AJEM12DWH
Built-in WiFi SmartHQ™	Yes	Yes	Yes	Yes	Yes
ADA-Compliant	Yes	Yes	Yes	Yes	Yes
Voltage / Hertz / Phase	115 / 60 / 1	230 / 208 / 60 / 1	230 / 208 / 60 / 1	230 / 208 / 60 / 1	230 / 208 / 60 / 1
BTUH - AHAM Cooling	8,300	10,000 / 9,800	12,000 / 11,700	14,000 / 13,600	12,000 / 11,700
Amps - AHAM	7.8	4.6 / 5.0	5.5 / 5.9	6.9 / 7.5	5.5 / 5.9
WATTS INPUT	840	1020 / 1000	1240 / 1210	1480 / 1430	1240 / 1210
EER	9.6	9.6 / 9.6	9.5 / 9.5	9.3 / 9.5	9.5 / 9.5
CEER	9.6	9.6 / 9.6	9.5 / 9.5	9.3 / 9.5	9.5 / 9.5
Dehumidification (Pts/Hr)	1.9	2.7 / 2.7	3.4 / 3.4	3.8 / 3.8	3.4 / 3.4
BTU Heating	4,200	10,600 / 8,600	10,600 / 8,600	10,600 / 8,600	10,600 / 8,600
Heating Amps	11.8	15 / 13.5	15 / 13.5	15 / 13.5	15 / 13.5
Heating Watts	1,320	3,450 / 2,821	3,450 / 2,821	3,450 / 2,821	3,450 / 2,821
Refrigerant Type	R410A	R410A	R410A	R410A	R410A
Electronic Control	Yes	Yes	Yes	Yes	Yes
Remote Control	Yes	Yes	Yes	Yes	Yes
24VAC Wall Thermostat Capable (RAK164D2, RAK164P2) - 8 Pin Quick Disconnect	YES	YES	YES	YES	YES
Line Cord Plug / Configuration	Parallel / NEMA 5-15P Right Angle LCDI	Perpendicular NEMA 6-20P Right Angle LCDI	Perpendicular NEMA 6-20P Right Angle LCDI	Perpendicular NEMA 6-20P Right Angle LCDI	Perpendicular NEMA 6-20P Right Angle LCDI
Fan Speeds	3	3	3	3	3
Centered Rear Condenser Coil - Compatible with RAG13/RAG13A / RAG14E Grille	YES	YES	YES	YES	YES
Chassis Width, Inches	26-2/32	26-2/32	26-2/32	26-2/32	26-2/32
Chassis Height, Inches	15-21/32	15-21/32	15-21/32	15-21/32	15-21/32
Chassis Depth	21-2/32	21-2/32	21-2/32	21-2/32	21-2/32
Approx. Net Weight (lbs.)	66	69	79	79	79
Approx. Shipping Weight (lbs.)	76	80	89	89	89

All 230/208V cooling units with electric heat models are corrosion treated. Design subject to change without notice.

Specifications subject to change. For complete specifications visit geappliances.com.

SPECIFICATIONS

HIGH-MOUNT

AJCQ12DWH	AJCQ14DWH	AJCM08AWH	AJCM10AWH	AJCM10DWH	AJCM12DWH
Yes	Yes	Yes	Yes	Yes	Yes
Yes	Yes	Yes	Yes	Yes	Yes
Yes	Yes	Yes	Yes	Yes	Yes
230 / 208 / 60 / 1	230 / 208 / 60 / 1	115 / 60 / 1	115 / 60 / 1	230 / 208 / 60 / 1	230 / 208 / 60 / 1
12,100 / 11,700	14,000 / 13,600	8,400	10,000	10,150 / 9,900	12,100 / 11,900
5.2 / 5.6	6.9 / 7.5	7.0	8.3	4.5 / 4.8	5.2 / 5.6
1140 / 1120	1490 / 1460	790	930	950 / 920	1140 / 1120
10.5	9.3/9.5	10.6	10.6	10.6/10.6	10.5/10.5
10.5	9.3/9.5	10.6	10.6	10.6/10.6	10.5/10.5
3.4 / 3.4	3.8/3.8	1.9	2.7	2.7 / 2.7	3.4 / 3.4
R410A	R410A	R410A	R410A	R410A	R410A
15	15	15	15	15	15
Tandem / NEMA 6-15P Right Angle LCDI	Tandem / NEMA 6-15P Right Angle LCDI	Parallel / NEMA 5-15P Right Angle LCDI	Parallel / NEMA 5-15P Right Angle LCDI	Tandem / NEMA 6-15P Right Angle LCDI	Tandem / NEMA 6-15P Right Angle LCDI
Yes	Yes	Yes	Yes	Yes	Yes
Yes	Yes	Yes	Yes	Yes	Yes
Rigid, tilt out / washable	Rigid, tilt out / washable	Rigid, tilt out / washable	Rigid, tilt out / washable	Rigid, tilt out / washable	Rigid, tilt out / washable
Yes	Yes	Yes	Yes	Yes	Yes
3	3	3	3	3	3
26-2/32	26-2/32	26-2/32	26-2/32	26-2/32	26-2/32
15-21/32	15-21/32	15-21/32	15-21/32	15-21/32	15-21/32
21-2/32	21-2/32	21-2/32	21-2/32	21-2/32	21-2/32
74	74	64	67	67	74
84	84	73	77	77	84

HEAT PUMP

MODELS	AJHQ08AWH	AJHQ12DWH
Built-in WiFi SmartHQ™	Yes	Yes
ADA-Compliant	Yes	Yes
Voltage / Hertz / Phase	115 / 60 / 1	230-208 / 60 / 1
BTUH Cooling	8,200	11,500 / 11,100
Amps	7.3	5.2 / 5.5
Watts Input	810	1,170 / 1,130
EER	9.8	9.6 / 9.6
CEER	9.8	9.6 / 9.6
Dehumidification (Pts / Hr)	1.9	3.4 / 3.4
Refrigerant Type	R410A	R410A
Reverse Cycle BTU Heating	6,650	8,500 / 8,300
Reverse Cycle Amps	6.0	4.6 / 5.0
Reverse Cycle Watts	650	1030 / 1010
COP	3.0	2.4
Resistance Heat BTU	4,200	10,600 / 8,600
Resistance Heat Amps (Max)	11.8	15.0 / 13.5
Resistance Heat Watts	1,320	3,450 / 2,821
24VAC Wall Thermostat Capable Requires - 8 Pin Thermostat Converter (sold separately)	YES	YES
Line Cord Plug / Configuration	Parallel / Right Angle LCDI	Perpendicular / Right Angle LCDI
Fan Speeds	3	3
Chassis Width, Inches	26-2/32	26-2/32
Chassis Height, Inches	15-21/32	15-21/32
Chassis Depth	21-2/32	21-2/32
Approx. Net Weight (lbs.)	72	82
Approx. Shipping Weight (lbs.)	83	92

For complete specifications visit geappliances.com.

BUILT-IN WALL AIR CONDITIONER

APPLICATIONS

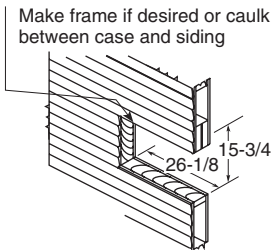

Frame Construction

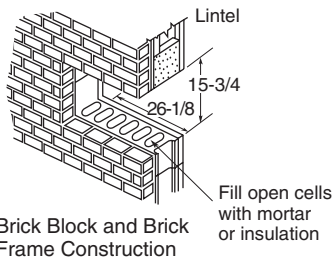

Brick Block and Brick Frame Construction

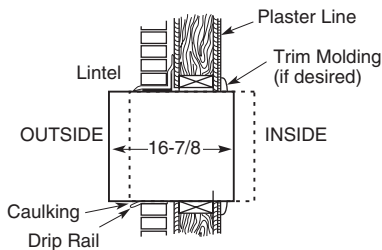

Flexible Mounting Position

OPENING FOR WALL SLEEVE RAB26A

A finished opening of 26-1/8" x 15-3/4", clear of intrusions, is required. Keep clearance of 4" from side walls. Brick veneer or frame walls should have wood studding surrounding case to provide firm anchoring with screws. Case can be fastened directly to brick or block walls with screws sunk in lead expansion shields.

Note: Units should be caulked on all four sides of case to the building exterior to assure building integrity.

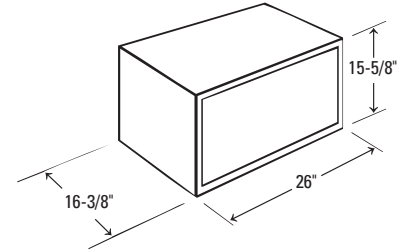
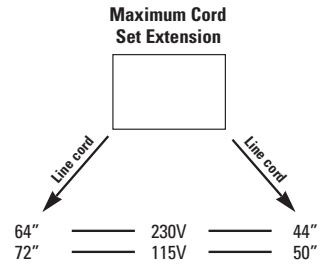

RAK26TO ADDITIONAL PANELS FOR 26" SLEEVE TENANT OPTION

- Compatible with RAB26A, RAB46A, RAB46B and RAB48B wall sleeves
- Use when wall sleeve is installed without a chassis to close off the interior from the outside elements
- Includes indoor steel insulated panel, vinyl weather barrier and hardware



RAB26A Wall Sleeve

- Universal design
- Heavy gauge construction
- Pre-installed gasketing on all sides ensures a tight seal
- Insulated side & top panels
- 4 PC "Quick Snap" design—short assembly required
- Uses RAD10 drain kit
- Color matched white
- RAK26TO Tenant option kit available
- RAG13A stamped aluminum grille included

PARTS & ACCESSORIES

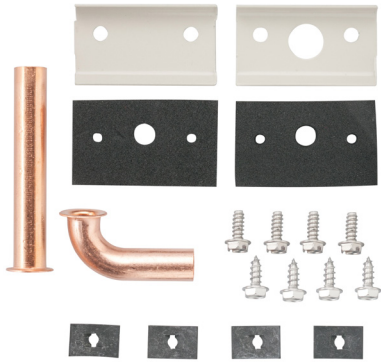

RAD10 Internal/External Drain Kit

- For use on RAB26A wall sleeves
- Routes condensate to exterior or interior of building through wall case
- Suitable provision (field supplied) should be made to connect the drain tube to a drain system in the building
- 1/2" OD copper assemblies include short right-angle tube and 3"-long straight tube
- NOT compatible with RAG14E exterior grille. Use of this grille would require the use of the internal tube configuration to drain the unit assure building integrity.

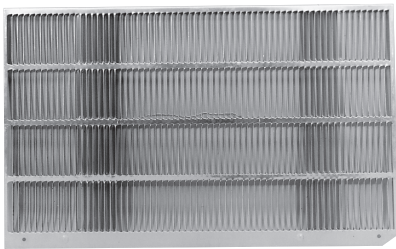

RAG13A Stamped Aluminum Exterior Grille For J Series

- Maximizes efficiency and capacity of new chassis
- Included with new wall case RAB26A

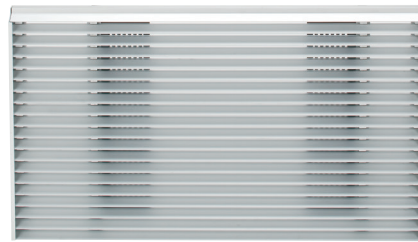

RAG14E Architectural Louvered Exterior Grille For J Series

- Extruded aluminum grille for application with RAB26A and older sleeves
- NOT compatible with RAD4A1 and RAD10 EXTERNAL drain kits. Use of this grille would require the use of the internal tube configuration to drain the unit

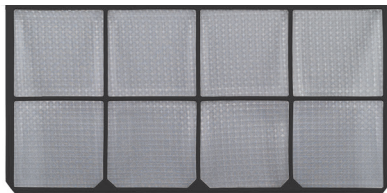

RAA85 Replacement Filter for AJ Models

- Convenient, washable slide-in filter

STAY COOL

Cooling comfort is now easy to enjoy and install with Universal Fit wall air conditioners.

Simple slide-in installation provides a precise fit into a variety of different wall sleeves.



UNIVERSAL FIT WALL AIR CONDITIONERS FEATURE HIGHLIGHTS



UNIVERSAL FIT

Simple slide-in installation is made for a precise fit into a variety of different wall sleeves. **Trim kit and installation kit included.**

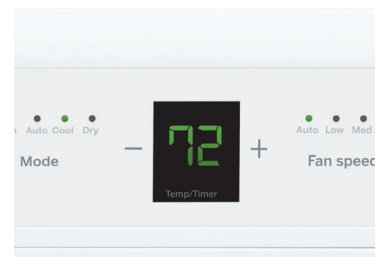

LARGE LCD DISPLAY

Intuitive & easy-to-read LCD display controls room air comfort at a single touch.



6-WAY DIRECTIONAL AIRFLOW

Direct where the air flows with up to 6 directional vent adjustments—cooling and/or heating the areas of the room that need it the most.



ECO MODE

Innovative mode where the fan cycles off between cooling intervals, saving energy while keeping the room comfortable.



DRY MODE

Designed for humid environments, it helps provide a dryer & more comfortable environment with room-air dehumidification.

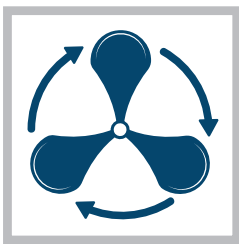

3-FAN SPEEDS

Select high, medium, low or auto setting to achieve the best in air comfort & ultimate flexibility.

PARTS & ACCESSORIES



RAB24 QUICK SNAP WALL SLEEVE

- Universal design
- Heavy gauge construction



EXTERIOR GRILLE

Stamped aluminum exterior grille for the RAB24 Quick Snap Wall Sleeve is included with the chassis.

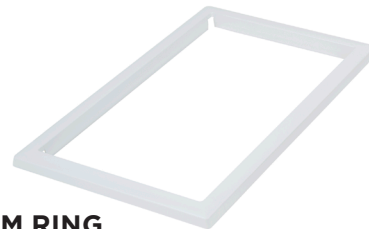

TRIM RING

Decorative trim included with unit, is used when chassis is installed on existing wall sleeves with different widths.

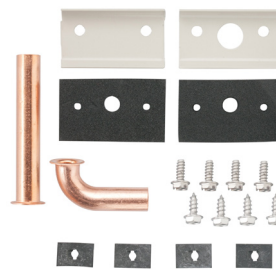

RAD10 DRAIN KIT

- Fits RAB24 wall sleeve
- Routes condensate to exterior or interior of the building
- 1/2" OD copper assemblies includes short right-angle tube and 3"-long straight tube
- Must be ordered separately

OTHER COMPONENTS

Also included with the product and used on existing 24" wall sleeves are:

- Foam pieces for filling gaps
- Security brackets
- Grounding wire

UNIVERSAL FIT COOL ONLY AIR CONDITIONERS

COOL-ONLY UNITS INCLUDE:

- ENERGY STAR® certified
- 3 fan speeds
- Electronic controls with remote
- Six-way air direction
- 24-hour timer
- ECO, DRY, AUTO modes



AKCQ10DCH
10,200/9,900 BTU, 10.6/10.6 CEER,
230/208 Volts

AKCQ12DCH
12,100/11,750 BTU, 10.5/10.5 CEER,
230/208 Volts

AKCQ14DCH*
14,000/14,000 BTU, 9.3/9.3 CEER,
230/208 Volts

*Not ENERGY STAR certified.

AKCQ08ACH
8,550 BTU, 10.6 CEER,
115 Volts

AKCQ10ACH
10,000 BTU, 10.6 CEER,
115 Volts

AKCQ12ACH
12,000 BTU, 10.5 CEER,
115 Volts

HEAT-COOL UNITS INCLUDE:

- 3 fan speeds
- Electronic controls with remote
- Six-way air direction
- 24-hour timer
- Electric heat
- ECO, DRY, AUTO modes



AKEQ10DCH
10,000/9,800 BTU, 9.6/9.6 CEER,
230/208 Volts

AKEQ12DCH
12,000/11,600 BTU, 9.5/9.5 CEER,
230/208 Volts

AKEQ14DCH
14,000/13,600 BTU, 9.3/9.5 CEER,
230/208 Volts

SPECIFICATIONS

COOL-ONLY

MODELS	AKCQ08ACH	AKCQ10ACH	AKCQ12ACH	AKCQ10DCH	AKCQ12DCH	AKCQ14DCH
Voltage - Frequency (Hz)	115 - 60	115 - 60	115 - 60	230 / 208 - 60	230 / 208 - 60	230 / 208 - 60
BTUH - AHAM	8,550	10,000	12,000	10,200 / 9,900	12,100 / 11,750	14,000 / 14,000
Amps- AHAM	7.1	8.3	10.0	4.5 / 4.8	5.2 / 5.6	6.9 / 7.5
EER	10.6	10.6	10.5	10.6 / 10.6	10.5 / 10.5	9.3
CEER	10.6	10.6	10.5	10.6 / 10.6	10.5 / 10.5	9.3
ENERGY STAR Certified	YES	YES	YES	YES	YES	NO
Dehumidification (Pints/Hr)	2.5	3.0	3.6	3.0	3.6	3.6
Refrigerant Type/Capacity	R410A 17.64 oz.	R410A 20.81 oz.	R410A 21.87 oz.	R410A 20.81 oz.	R410A 21.87 oz.	R410A 21.52 oz.
Fan Speeds	3	3	3	3	3	3
Air Flow Volume (CFM)						
High	252	269	286	275	277	295
Med	217	234	258	240	258	275
Low	189	203	235	209	235	252
Compressor Type	Rotary	Rotary	Rotary	Rotary	Rotary	Rotary
Plug Capacity (15A Circuit Size)	125V / 120V / 15A	125V / 120V / 15A	125V / 120V / 15A	240V / 250V / 15A	240V / 250V / 15A	240V / 250V / 15A
Line Cord Plug / Configuration	A / 5-15P	A / 5-15P	A / 5-15P	B / 6-15P	B / 6-15P	B / 6-15P
On/Off Timer (24 Hour)	Yes	Yes	Yes	Yes	Yes	Yes
Energy Saver (Eco Mode)	Yes	Yes	Yes	Yes	Yes	Yes
Auto Fan	Yes	Yes	Yes	Yes	Yes	Yes
Dehumidify Function	Yes	Yes	Yes	Yes	Yes	Yes
Sleep Mode	Yes	Yes	Yes	Yes	Yes	Yes
Wall Sleeve (Sold Separately) - RAB24, RAB26*, RAB46*, RAB48*	Optional, Not Included	Optional, Not Included	Optional, Not Included	Optional, Not Included	Optional, Not Included	Optional, Not Included
Dimensions & Installation	Wall	Wall	Wall	Wall	Wall	Wall
Wall Case Required	Yes	Yes	Yes	Yes	Yes	Yes
Unit Dimensions (Inches)						
Width	24 4/19	24 4/19	24 4/19	24 4/19	24 4/19	24 4/19
Height	14 9/17	14 9/17	14 9/17	14 9/17	14 9/17	14 9/17
Depth	19	19	19	19	19	19
Net Weight (lbs.)	66	69	77	69	76	77
Approx. Shipping Wt. (lbs.)	77	81	88	81	87	89

HEAT COOL MODELS

MODELS	AKEQ10DCH	AKEQ12DCH	AKEQ14DCH
Voltage - Frequency (Hz)	230 / 208 - 60	230 / 208 - 60	230 / 208 - 60
BTUH - AHAM	10,000 / 9,800	12,000 / 11,600	14,000 / 13,600
Amps- AHAM	4.6 / 5.0	5.5 / 5.9	6.9 / 7.5
EER	9.6 / 9.6	9.5 / 9.5	9.3 / 9.5
CEER	9.6 / 9.6	9.5 / 9.5	9.3 / 9.5
ENERGY STAR Certified	NO	NO	NO
Dehumidification (Pints/Hr)	3.0	3.6	3.6
Refrigerant Type/Capacity	R410a 17.99 oz	R410A 21.87 oz.	R410A 21.52 oz.
Resistance Heat BTU	10,600 / 8,600	10,600 / 8,600	10,600 / 8,600
Resistance Heat AMP	15 / 13.5	15 / 13.5	15 / 13.5
Resistance Heat WATTS	3450 / 2821	3450 / 2821	3450 / 2821
Fan Speeds	3	3	3
Air Flow Volume (CFM)			
High	292	286	282
Med	275	264	263
Low	252	240	244
Compressor Type	Rotary	Rotary	Rotary
Plug Capacity (15A Circuit Size)	240V / 20A	240V / 20A	240V / 20A
Line Cord Plug / Configuration	6-20P	6-20P	6-20P
On/Off Timer (24 Hour)	Yes	Yes	Yes
Energy Saver (Eco Mode)	Yes	Yes	Yes
Auto Fan	Yes	Yes	Yes
Dehumidify Function	Yes	Yes	Yes
Sleep Mode	Yes	Yes	Yes
Wall Sleeve (Sold Separately) - RAB24, RAB26*, RAB46*, RAB48*	Optional, Not Included	Optional, Not Included	Optional, Not Included
Dimensions & Installation	Wall	Wall	Wall
Wall Case Required	Yes	Yes	Yes
Unit Dimensions (Inches)			
Width	24 4/19	24 4/19	24 4/19
Height	14 9/17	14 9/17	14 9/17
Depth	19	19	19
Net Weight (lbs.)	69	79	80
Approx. Shipping Wt. (lbs.)	80	90	91

*Must use provided trim kit

BUILT-IN WALL AIR CONDITIONERS NOMENCLATURE

The built-in air conditioner chassis is identified by a model number defining the type of unit, cooling capacity, electrical information and optional features included on the unit. When specifying or ordering the built-in air conditioner chassis, use of this nomenclature will assure receiving the correct unit.

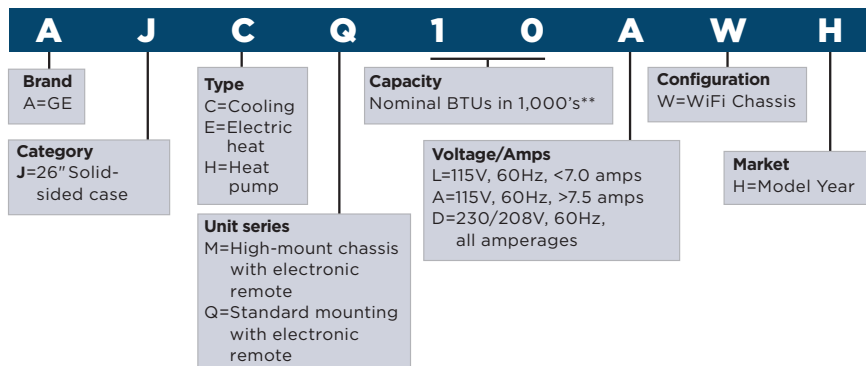

UNIVERSAL FIT AIR CONDITIONERS NOMENCLATURE

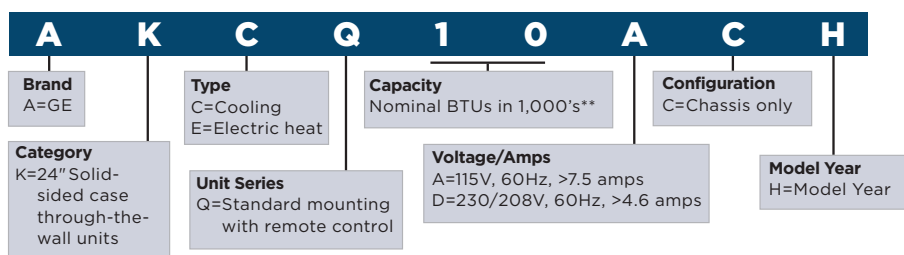

GE APPLIANCES BUILT-IN WALL AIR CONDITIONERS WARRANTY*

FOR THE PERIOD OF	GE APPLIANCES WILL REPLACE
TWO YEARS From the date of the original purchase	Any part of the air conditioner which fails due to a defect in materials or workmanship. During this limited two-year warranty , GE Appliances will provide, free of charge , all labor and related service costs to replace the defective part.
FIVE YEARS From the date of the original purchase	Sealed Refrigerating System - if the Sealed Refrigerating System (compressor, condenser, evaporator, and all connecting tubing) should fail due to a defect in materials or workmanship. During this limited five-year warranty , GE Appliances will provide, free of charge , all labor and related service costs to replace the defective part.

GE APPLIANCES UNIVERSAL FIT AIR CONDITIONERS WARRANTY*

FOR THE PERIOD OF	GE APPLIANCES WILL REPLACE
TWO YEARS From the date of the original purchase	Any part of the air conditioner which fails due to a defect in materials or workmanship. During this limited two-year warranty , GE will provide, free of charge , all labor and related service costs to replace the defective part.

*See written warranty for complete details.

**Approximate—see product specs for actual performance.



GE APPLIANCES
a Haier company

GE is a trademark of the General Electric Company.
Manufactured under trademark license.

Appliance Park
Louisville, KY 40225
geappliances.com
© 2021 GE Appliances
Pub No. 20-S0521
OTGEA21057